



XIAMEN TAKAM MACHINERY CO., LTD.
260 North Tongji Road,
Tong'an district,
Xiamen City, China.
Tel:+0086-592-7362548 Fax:+0086-592-7362540
Website: www.takam.com

High Agility
High Performance.

Introducing the most advance
TA-Series we ever built.



When structure is everything, the TA-Series does not disappoint. With one of the widest stance in its class, the machine is more than capable of handling even the toughest cutting jobs the industry has to offer.

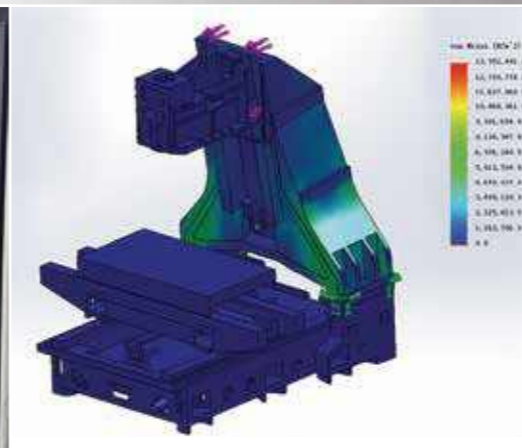
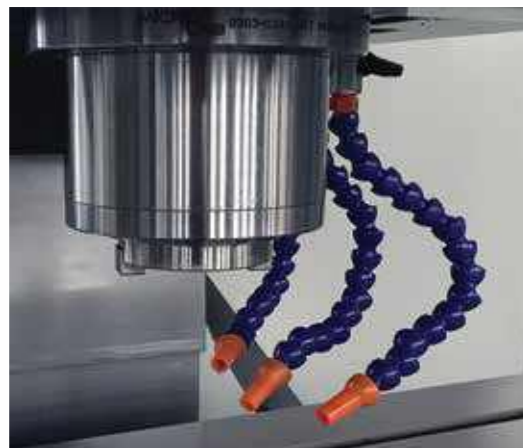

Spindle technology

Separate is better

Designed with technology

The advanced design of our spindles provides high axial thrust capability, yet generates minimal heat. The spindles use front and rear pre-load angular bearing with large spacers to enhance radial stability enabling heavy cuts on steel. To ensure pro-long life of the spindle high temperature grease is used to guarantee smooth operations of the spindle regardless of operation temperature.

Many machines face overheating and noise from high voltage amps that are installed in the electronic cabinets. The TA-Series machine was designed to avoid all these problems. By separating all the high voltage from the low voltage parts, the machine is able to reduce heat and noise from high voltage units affecting the low voltage units.

TA-Series was designed with the most advanced FEM analysis software on the market. We are able to test our design under many different stressed conditions. This gives us the ability to design the TA-Series machine to not only meet our customers requirements, but to surpass our customers needs. This gives the customer more value because of our design.

Performance Diagrams-Mitsubishi

TA-745/850 Mitsubishi-Driver

TA-1062 (TA-745/850 Optional) Mitsubishi-Driver

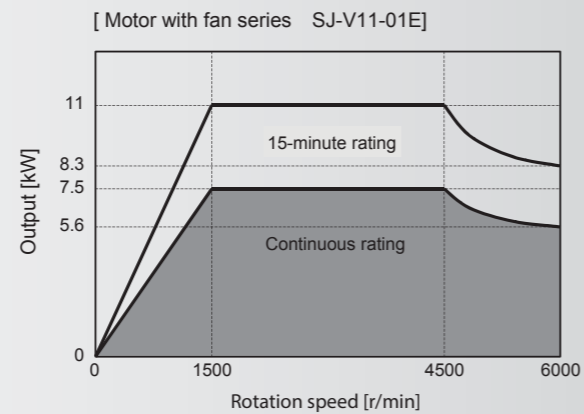
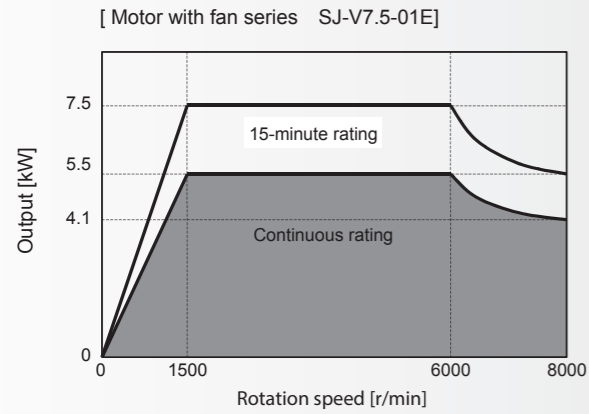

TA-1062 Mitsubishi-Driver Optional

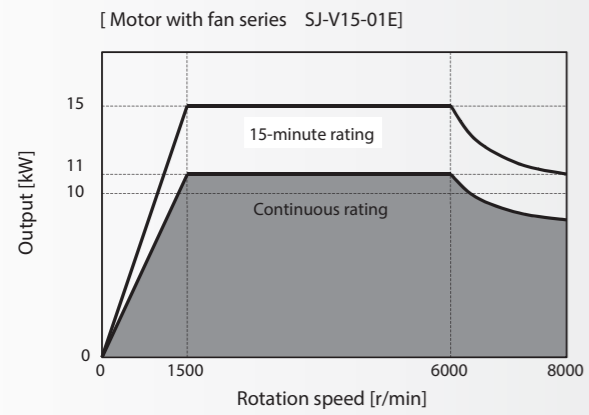

Performance Diagrams-Siemens

TA-745/850 Siemens-Driver

TA-1062 (TA-745/850 Optional) Siemens-Driver

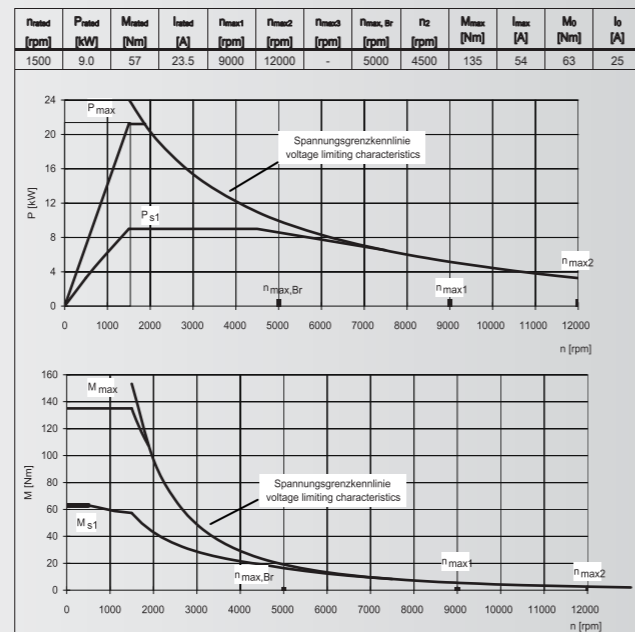
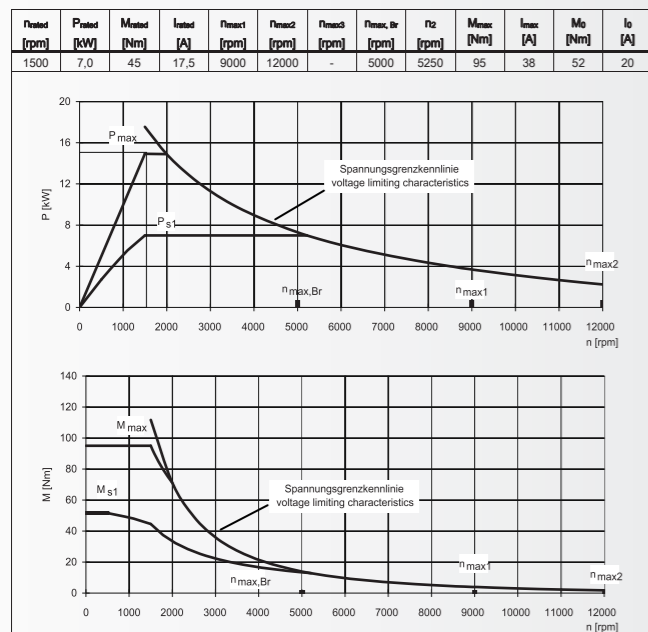

TA-1062 Siemens-Driver Optional

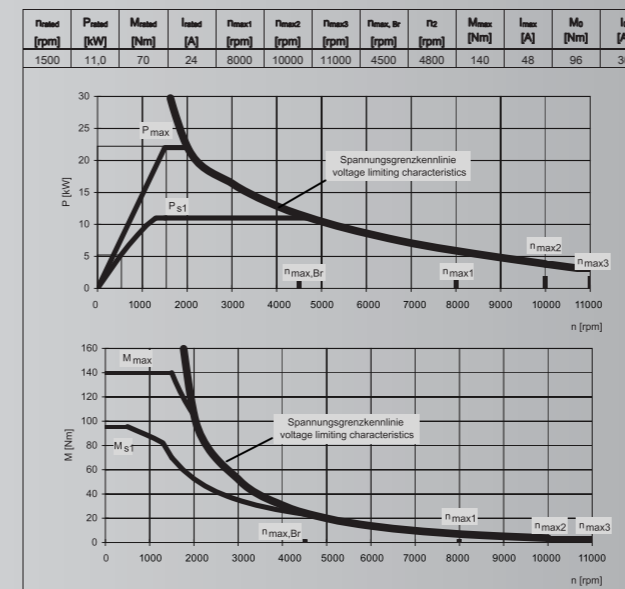

Performance Diagrams-Fanuc

TA-745/850 Fanuc-Driver

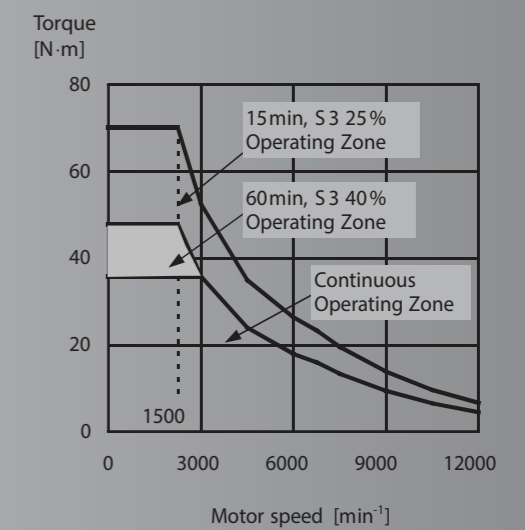
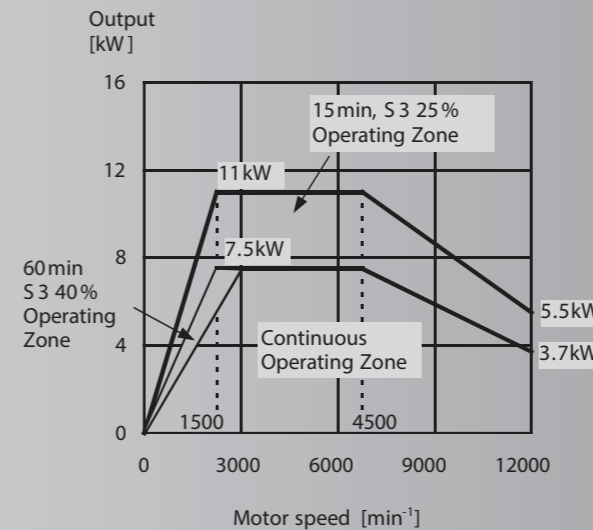

TA-1062 Fanuc-Driver

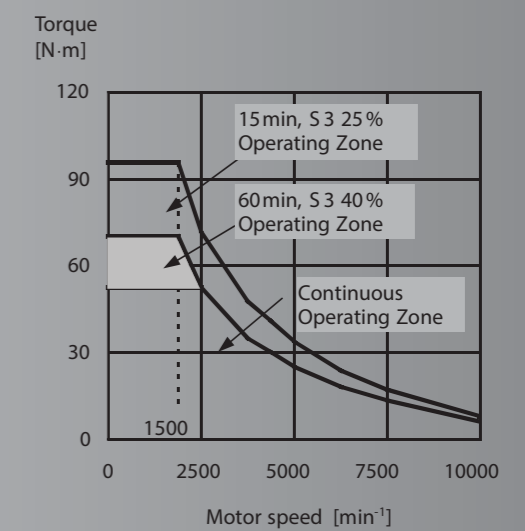
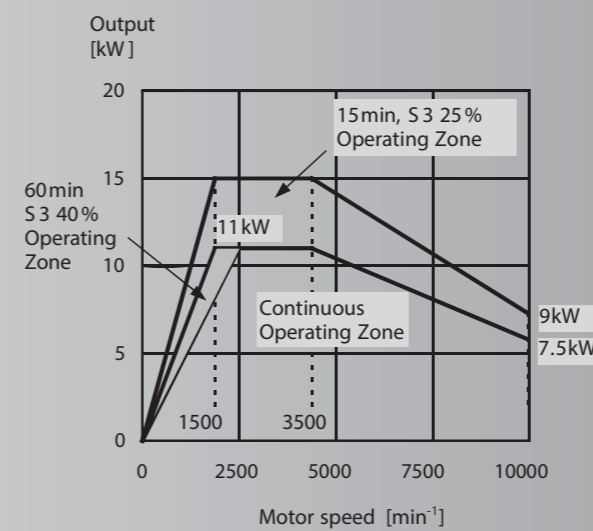

Work Piece Size

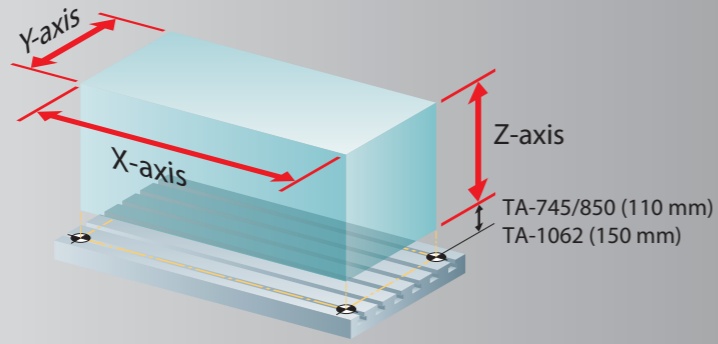

	Units	TA-745	TA-850	TA-1062
X-Axis	mm	700	800	1000
Y-Axis	mm	420	520	620
Z-Axis	mm	550	550	550

Floor Plans

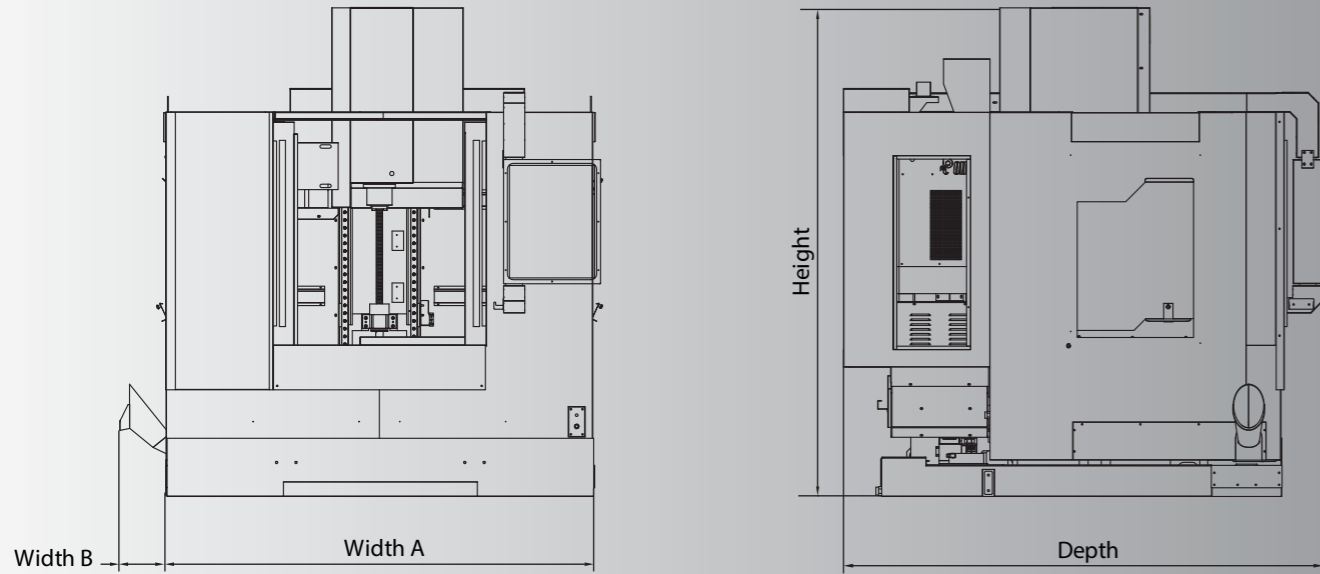

	Units	TA-745	TA-850	TA-1062
Depth	mm	2472	2472	2480
Width A	mm	2200	2200	2700
Width B	mm	238	238	238
Height Min	mm	2260	2260	2290
Height Max	mm	2520	2520	2720

Technical Data

	TA-745	TA-850	TA-1062
Table			
Area of Table (mm)	900 x 450	900 x 500	1000 x 600
Working Area (mm)	700 x 420	800 x 520	1000 x 620
T-Slot (mm)	80 x 18 x 5	80 x 18 x 5	100 x 18 x 5
Work Table Max Weight (kgs)	400	400	800
Travel			
X/Y/Z - Axis Travel (mm)	700/420/550	800/520/550	1000/620/550
Spindle Nose to Table surface (mm)	110-660	110-660	150-700
X/Y/Z-Guideway Type	Linear Guideway	Linear Guideway	Linear Guideway
Spindle			
Spindle Taper	BT40	BT40	BT40
Spindle rpm	8000	8000	8000
Transmission Method			
Spindle Motor (kw)-Fanuc	7.5	7.5	11.0
Spindle Motor (kw)-Mitsubishi	7.5	7.5	7.5
Spindle Motor (kw)-Siemens	7.0	7.0	7.0
Spindle Motor (kw)-Heidenhain	7.5	7.5	7.5
Three-Axis Motor			
X/Y/Z-Axis Servo Motor (kw)-Fanuc	1.8/1.8/3.0BS	1.8/1.8/3.0BS	3.0/3.0/3.0BS
X/Y/Z-Axis Servo Motor (kw)-Mitsubishi	1.5/1.5/3.0BS	1.5/1.5/3.0BS	3.0/3.0/3.0BS
3-Axis Cutting Feed Rate (mm/min)	10000	10000	
3-Axis Rapid Traverse (m/min)	36/36/36	36/36/36	36/36/36
Others			
Machine Weight / Gross Weight (kgs)	3800	4000	5000
Control			
TA-Series Control	Fanuc Oi-MF, Mitsubishi M80A/M80B, Siemens 828D/840D, Heidenhain TNC620/TNC640		

Standard

- Enclosed Guard
- Swiveling Control Box
- Low Energy Work Light
- LED 3 Color Warning Light
- Volumetric Type Automatic Lubricator
- Auto Power Off
- Rigid Tapping
- Tool Box
- Leveling Screws & Blocks
- Operation Manual
- Air Gun
- Mechanical Oil Coolant Separator

Options

- Tool Changer 16/20/24/30/32
- Spindle Upgrade to Direct Drive 10000/12000/15000 rpm
- Spindle Upgrade Belt Type 10000/12000 rpm
- Spindle Upgrade Built-in 18000/24000 rpm
- Screw Type Chip Conveyor
- Chain Type Chip Conveyor
- Chip Wash System
- Tool measuring system
- Tool breakage system
- Linear Scale
- Coolant Through Spindle - 6/20/30/50/70 bar.
- Air Through Spindle